

MIRI[®]

ESCO
MEDICAL

Evidence

RFID Witnessing & Traceability System



MIRI[®] Evidence

Witnessing and traceability systems are an essential safeguard, ensuring that the right gametes, embryos, and patient information are correctly identified and utilized throughout the laboratory procedures. The MIRI[®] Evidence RFID witnessing and traceability system assures embryologists/clinicians and provides a detailed chain of custody for the complete cycle process.

- Enhancing working accuracy by preventing mistakes from being made throughout a cycle.
- Reduced risk of legal dispute by providing a detailed chain of custody record of the cycle. The chain of custody serves as a valuable resource, allowing embryologists to review and analyze the steps taken, ensuring adherence to protocols, and facilitating continuous improvement.
- Offering a sense of working security, knowing the correct gametes and embryos are always being handled. Embryologists can approach their work confidently, focusing on providing the best patient care while minimizing the possibility of mix-ups or errors.



MIRI[®] Evidence is the ultimate witnessing and traceability tool for fertility clinics.

The MIRI[®] Evidence system includes advanced tools to improve scheduling and documentation procedures, refining both clinical and administrative processes in fertility clinics. As soon as the patient begins treatment, tasks and procedures are automatically arranged and scheduled. Any changes to the treatment will initiate an update on the scheduled task. The built-in validation system ensures that all data is accurately registered. If data is missing, a task is automatically created for the responsible person or group to provide the necessary information.

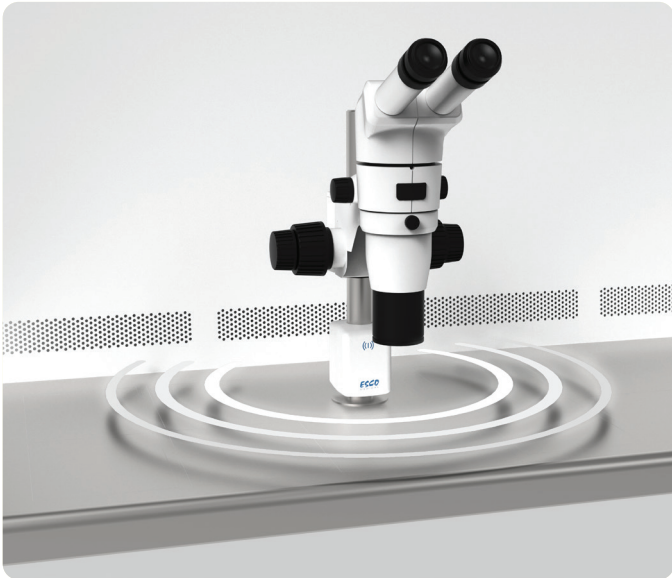

The MIRI[®] Evidence system uses hybrid human-readable RFID labels for the dishes to prevent mix-ups, allowing zero possibility for error. The MIRI[®] Evidence Pole reader automatically imparts 270° of coverage in the work area of the IVF workstation.

MIRI[®] Evidence in the IVF Clinic

The MIRI[®] Evidence system covers the flow from the Ovum Pickup via cryopreservation to the transfer of the embryo. Every step is secured.

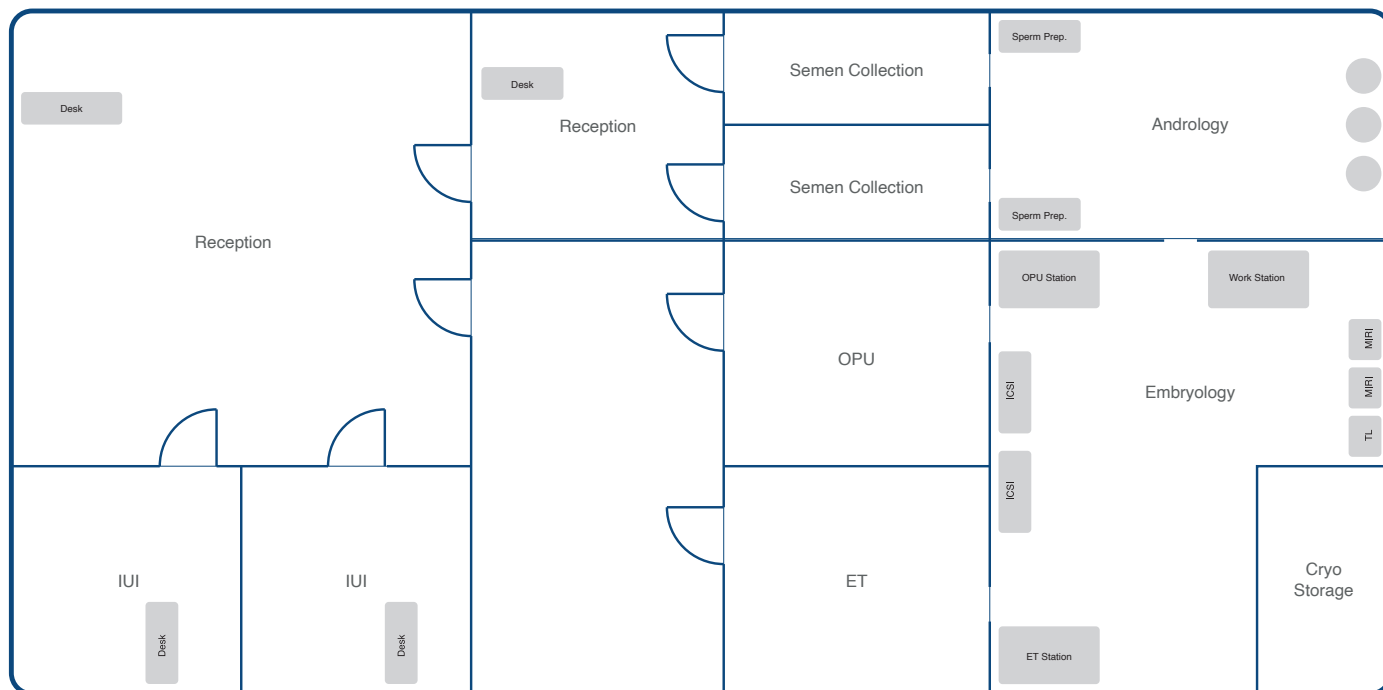

Reception

A designated area in the IVF clinic where patients are registered in preparation for their procedure.

Admission for patients includes appointment and identity verification by capturing ID from a driver's licence, passport or national ID. For female patients, wristband printing and documentation of attachment of wristband, while for male patients – labelling a handout cup or in case of cup handin – time and location of sample production as well as labelling of the cup.



Andrology Laboratory

A designated area in the IVF clinic where lab technicians or embryologists perform sperm preparation, cryopreservation and diagnostic analysis of samples. Having RFID witnessing and traceability systems in place in the andrology lab will help eliminate the need for double witnessing, increasing procedure efficiency and uninterrupted workflow.



Embryology Laboratory

A designated area in the IVF clinic where various procedures are performed, i.e., denudation, vitrification, thawing, ICSI, insemination (IVF), embryo grading and assessment, embryo incubation and media preparation. Having RFID witnessing and traceability systems in place in the embryology lab will help eliminate the need for double witnessing, increasing procedure efficiency to ensure the transfer of gametes between verified tubes and dishes. MIRI® Evidence RFID Witnessing and Traceability System includes the feature for complete registration of all utensils LOTs used during the treatment.



Examination Rooms and Theaters

The designated area within the IVF clinic is where the embryologist, doctor or nurse confirms the patient's identity by scanning the wristband attached to the patient.



Cryopreservation

Straws of the embryo(s) or semen samples are labelled with both human-readable and barcode labels to allow accurate verification of the straws before thawing or warming.

Key Features

Hybrid RFID Label

MIRI® Evidence uses an intuitive labelling system that makes use of human-readable labeling, universal data matrix code and RFID tags. This combination on each label offers a powerful solution to improve efficiency, accuracy, traceability, and security in embryology labs. It minimizes the potential for errors, enhances quality assurance, and ultimately contributes to better patient care and treatment outcomes.



Complete labels for your labware

Complete range of labels for your specimen cups, conical tubes, culture dishes, and vitrification straws

MIRI® Evidence allows you to use different label layouts for different types of containers, allowing you to show both patient and partner names on the semen sample label. The physical size of the label limits the information that can be shown on the label. All label lots are MEA tested and ready to use.

Secure Printing

The RFID printer prints and programs the RFID label in one operation to ensure that the patient name on the label and the RFID chip refers to the same patient. The printer validates the RFID chip during the printing process. If the RFID chip is not passing validation, a "VOID" is printed on top of the label, effectively mitigating the case where the label is human-readable but can not be detected by the RFID reader.

Easy Retrofitting

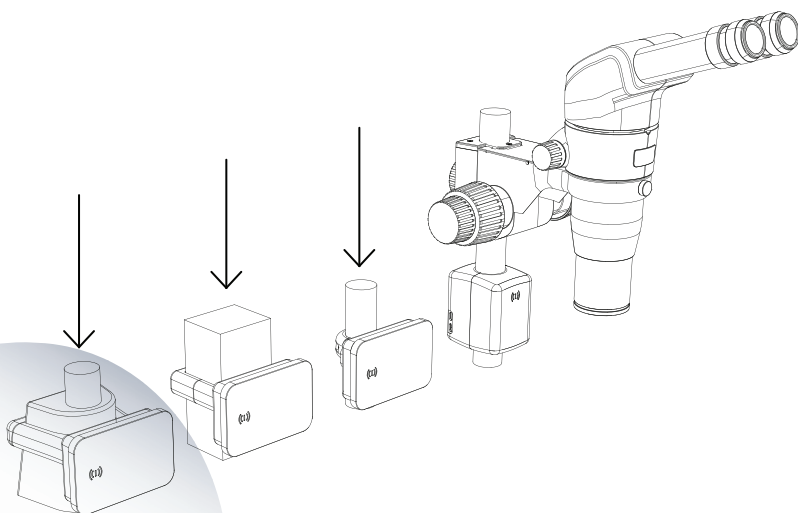

MIRI® Evidence Pole Reader can be retrofitted to existing equipment. There is no need to replace or do customizations on the tabletop of your workstations. Our RFID Pole reader is compatible with most available workstations in the market. Aside from that, an incubator monitor can be designated to display whose embryo has been assigned to which specific chamber of the incubator. The monitor is compatible with various kinds of embryo culture incubators on the market.



MIRI® Evidence Arc Reader

The MIRI® Evidence Arc Reader can be used as an alternative to the Pole reader, which can be equipped with brackets that fit depending on the shape of the microscope pole within the workstation.

Chain of Custody

MIRI® Evidence provides a simple automated process for generating a chain of custody for the gametes handled in your clinic. This automated process generates accurate and reliable records detailing every step involved, from procurement of semen samples and oocytes to final transfer to the recipient. It includes comprehensive documentation of all equipment used, such as dishes, tubes, straws, incubators, workstations, and ICSI stations, ensuring precise tracking of each specimen's journey. Additionally, essential documentation for the disposal of containers is also meticulously maintained, providing complete transparency and accountability throughout the entire process.

The chain of custody contains valuable data that can also be used to generate KPIs for different process steps, such as ICSI, Denudation, etc., and troubleshoot issues, such as incubator performance.

Oocyte	#OPU	Location			Current destiny
	1	7/4/2022 9:30 AM			OR1
					ET
Date	Event	Source	Destiny	Location	Actor
Specimen					
7/4/2022 9:30 AM	Oocyte Recovery	Stitt, Sacha (820110V445) ✓	OPU Needle (Saturn.OR1)	OR1	ViRi
7/4/2022 9:30 AM	Object move	OPU Needle (Saturn.OR1)	Opu set (Saturn.Embryo Lab.ERMOPU2)	ERMOPU2	FrCo
7/4/2022 9:30 AM	Object move	Opu set (Saturn.Embryo Lab.ERMOPU2)	HEPES (Saturn.Sperm section.SWS09816)	ERMOPU2	FrCo
7/4/2022 9:39 AM	Object move	HEPES (Saturn.Sperm section.SWS09816)	OPU G1 (Saturn.Sperm section.SWS09132)	ERMOPU2	FrCo
7/4/2022 9:39 AM	Object move	OPU G1 (Saturn.Sperm section.SWS09132)	Insem#2 (Saturn.Sperm section.SWS09132)	ERMOPU2	FrCo
7/5/2022 8:26 AM	Object move	Insem#2 (Saturn.Sperm section.SWS09132)	µGPS#3 (Saturn.Sperm section.SWS09816)	ERM-Window	laVi
7/7/2022 1:29 PM	*4001*	µGPS#3 (Saturn.Sperm section.SWS09816)	Catheter (Saturn.Embryo Lab.ERM3-X)	ERM3-X	SaRe
7/7/2022 1:30 PM	ET Doctor	Catheter (Saturn.Embryo Lab.ERM3-X)	Stitt, Sacha (820110V445) ✓	Embryotransfer Room (E495)	ViRi
Movements					
7/4/2022 9:40 AM	Object move	Insem#2 (Saturn.Embryo Lab.ERMOPU2)	Miri 2.3	ERMOPU2	FrCo
7/4/2022 2:17 PM	Object move	Insem#2 (Miri 2.3)	Saturn.Embryo Lab.ERM-Window	ERM-Window	SaRe
7/4/2022 2:19 PM	Object move	Insem#2 (Saturn.Embryo Lab.ERM-Window)	Miri 2.3	ERM-Window	SaRe
7/5/2022 8:22 AM	Object move	Insem#2 (Miri 2.3)	Saturn.Embryo Lab.ERM-Window	ERM-Window	laVi
7/5/2022 8:26 AM	Object move	µGPS#3 (Saturn.Embryo Lab.ERM-Window)	Saturn.Embryo Lab.ICSI221	ICSI221	laVi
7/5/2022 8:28 AM	Object move	µGPS#3 (Saturn.Embryo Lab.ICSI221)	Miri 2.3	ICSI221	laVi
7/7/2022 8:21 AM	Object move	µGPS#3 (Miri 2.3)	Saturn.Embryo Lab.ICSI1	ICSI1	NoPe
7/7/2022 8:23 AM	Object move	µGPS#3 (Saturn.Embryo Lab.ICSI1)	Incubator ET .1	ICSI1	NoPe
7/7/2022 11:54 AM	Object move	µGPS#3 (Incubator ET .1)	Saturn.Embryo Lab.IHM014	IHM014	ChTø
7/7/2022 11:56 AM	Object move	µGPS#3 (Saturn.Embryo Lab.IHM014)	Incubator ET .1	IHM014	ChTø
7/7/2022 1:25 PM	Object move	µGPS#3 (Incubator ET .1)	Saturn.Embryo Lab.ERM3-X	ERM3-X	SaRe
Bin					
7/4/2022 9:37 AM	Discard	OPU Needle (Saturn.OR1)	Bin	OR1	ViRi
7/4/2022 9:40 AM	Discard	OPU G1 (Saturn.Embryo Lab.ERMOPU2)	Bin	ERMOPU2	FrCo
7/4/2022 9:40 AM	Discard	HEPES (Saturn.Embryo Lab.ERMOPU2)	Bin	ERMOPU2	FrCo
7/4/2022 9:41 AM	Discard	Opu set (Saturn.Embryo Lab.ERMOPU2)	Bin	ERMOPU2	FrCo
7/5/2022 8:26 AM	Discard	Insem#2 (Saturn.Embryo Lab.ERM-Window)	Bin	ERM-Window	laVi
7/7/2022 1:31 PM	Discard	µGPS#3 (Saturn.Embryo Lab.ERM3-X)	Bin	ERM3-X	SaRe
	2	7/4/2022 9:31 AM			OR1
					Freeze

Automatic Mismatch Prevention

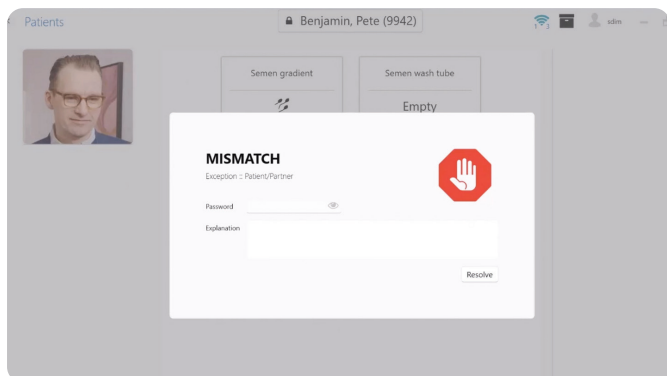

The **RFID technology** system employed in the MIRI® Evidence will automatically detect any mismatch during a procedure once a labelled dish is placed within the area covered by the MIRI® Evidence Pole reader, Arc reader and Tube reader.

Eliminate the need for **double witnessing** with continuous monitoring of the workspace through RFID tags

MIRI® Evidence RFID traceability system can provide detailed logs and records of all procedures, including item usage and any detected discrepancies. This feature enables efficient auditing and traceability, enhancing quality control and accountability in forensic or laboratory settings.

Incubator Signage



MIRI® Evidence tracks which incubator or chamber was used during incubation. You can add a signage display that shows which dish is located in which position, making it easier to locate the dish. This feature is available for any incubator, regardless of make or brand.

The signage display serves as an advanced data logger for MIRI® incubators, gathering all incubation data for future analysis. You can review the data by incubator position or directly on the dish/embryo level, providing comprehensive documentation of the treatment.

Utensils/Consumables

You can easily register the utensils and lots you use by scanning the GS1 barcodes (GS1-128) provided on the manufacturer's packaging material.

Date	Utensil	Lot No	Container Name	Event	User
07/04/2022 08.55	µDrop GPS Dish - MGPS-010	1293906	µGPS#2	Prepare containers	ToFI
07/04/2022 08.55	OIL FOR TISSUE CULTURE - ART-4008-5P	211210-003021	µGPS#2	Prepare containers	ToFI
07/04/2022 08.55	global® Total® LP - H5GT-060	220211-004436	µGPS#2	Prepare containers	ToFI
07/04/2022 09.01	5-well dish - 16004	12260	HEPES	Prepare containers	CHTø
07/04/2022 09.01	OIL FOR TISSUE CULTURE - ART-4008-5P	211210-003021	HEPES	Prepare containers	CHTø
07/04/2022 09.01	global® total® LP w/HEPES - H5TH-050	220204-004286	HEPES	Prepare containers	CHTø
08/04/2022 07.42	Hyaluronidase - 4HY-0010	HYA-2125	HYA#1	Prepare containers	AlGa
08/04/2022 07.42	Universal GPS dish - UGPS-010	1293905	HYA#1	Prepare containers	AlGa
08/04/2022 07.42	OIL FOR TISSUE CULTURE - ART-4008-5P	211210-003021	HYA#1	Prepare containers	AlGa
08/04/2022 07.51	PVP - 4PVP-001	PVP-2114	PVP#2	Prepare containers	AlGa
08/04/2022 07.51	OIL FOR TISSUE CULTURE - ART-4008-5P	211210-003021	PVP#2	Prepare containers	AlGa
08/04/2022 07.51	global® Total® LP - H5GT-060	220211-004436	PVP#2	Prepare containers	AlGa
08/04/2022 07.51	Culture dish 60mm - 16002	210404	PVP#2	Prepare containers	AlGa
08/04/2022 09.57	NaCl 0.9% - 3620204	212268061	OPU Needle	Prepare containers	HeKo
08/04/2022 09.57	ASPIRATION NEEDLE - K-OPSD-1630-B-L	A1083734	OPU Needle	Prepare containers	HeKo
08/04/2022 09.57	Plastipak Syringe 50/60m - 300865	2110054	OPU Needle	Prepare containers	HeKo
08/04/2022 09.57	Heparin LEO 5000 IE/ml - 585679	C55768	OPU Needle	Prepare containers	HeKo
08/04/2022 10.00	BD Emerald 10ml syringe - 307736	2110187	Opu set	Prepare containers	CHTø
08/04/2022 10.00	RI EZ-Squeeze 600um - 7-72-3600	218058	Opu set	Prepare containers	CHTø
08/04/2022 10.00	Plastipak Syringe 50/60m - 300865	2110054	Opu set	Prepare containers	CHTø
08/04/2022 10.00	NUNC IVF petri dish 90x17 - 150360	169632	Opu set	Prepare containers	CHTø
14/04/2022 11.59	HSV Kits - green - 025251	CBS019229	12 D6	Prepare containers	AlGa
22/06/2022 13.49	Nunc IVF Petri Dish 60x15 - 150270	172628	Petri#2	Prepare containers	LiBr
22/06/2022 13.49	OIL FOR TISSUE CULTURE - ART-4008-5P	211210-003021	Petri#2	Prepare containers	LiBr
22/06/2022 13.49	global® Total® LP - H5GT-060	220506-006235	Petri#2	Prepare containers	LiBr

You can either use the lot management system to start and close the use of the lot or scan the barcode or datamatrix code when you use it.

Labotect

Embryo Transfer Catheter 23 cm

for transvaginal embryo transfer

REF 13369

LOT 1909

2019-09-03

2024-08-31

GTIN: 04046668003317



(01) 04046668003317
(17) 240831 (11) 190903
(10) 1909

Store in a dark, cool, dry place.



STERILE | R |



0123

Two cell mouse embryo assay tested and passed with >80% blastocyst rate. USP endotoxin (LAL) tested and passed with <20 EU/device. Testing is conducted on a lot-to-lot basis.

Application by specially trained personnel only. Do not use if package is damaged. Caution: U.S.-Federal Law restricts this device to sale by or on the order of a physician. Anwendung nur durch speziell ausgebildetes Fachpersonal. Bei beschädigter Verpackung nicht verwenden.

Rev.00-082019

Labotect Labor-Technik-Göttingen GmbH, Kampweg 12, 37124 Rosdorf, Germany
Phone: +49 551 505010 E-Mail: info@labotect.com

Made in Germany

Cycle Credits

We have designed the MIRI® Evidence concept to encourage the labelling of all containers used for gametes and embryos. Labelling only key containers introduces false safety.

MIRI® Evidence automatically registers all events and container movements despite you not following the protocol. Deviations from the protocol can easily be revealed in the “chain of custody” log.



With MIRI® Evidence Cycle Credits, you get RFID labels for all containers, updates, and support. This comprehensive package ensures you get a reliable traceability system.

We offer two types of cycle credits:

- Major: Ovum Pickups (including IVF, ICSI, Transfer and Cryo procedure)
- Minor: Frozen Embryo Transfer + IUI

As long as you have available credits, you can issue RFID labels for diagnostic semen samples.



Deploying MIRI® Evidence

MIRI® Evidence is designed to be installed as an integrated part of your clinic’s network. You can install the application on any PC in the network. The server can be hosted as a virtual server, integrated into your domain, or delivered as a standalone server. In case of any installation and daily issues, our regional support team is available to help you.

The MIRI® Evidence server seamlessly exchanges information with your existing EMR or HIS system using HL7 or custom integration plugins, ensuring smooth operation.

General Specifications

MIRI® Evidence Tube Reader



Technical Specifications	Description
Device dimensions (L×W×H)	250mm×170mm×150mm
Supply Voltage	5V
Current Rating	2.5A
Maximum Power Load	12.5W*
USB-C with PD	2 ports
Max Radiated Power	2W / 33dBm
External/Auxiliary device	Maximum 0.8A
Weight	1484g
Scanning area range	270°

* Total of external devices including RFID reader.

MIRI® Evidence Pole Reader



Technical Specifications	Description
Device dimensions (L×W×H)	61mm×74mm×87mm
Supply Voltage	5V
Current Rating	2.5A
Maximum Power Load	12.5W*
USB-C with PD	2 ports
Max Radiated Power	2W / 33dBm
External/Auxiliary device	Maximum 0.9A
Weight	430g
Scanning area range	270°

* Total of external devices including RFID reader.

MIRI® Evidence Arc Reader



Technical Specifications	Description
Device dimensions (L×W×H)	30mm×110mm×74mm
Supply Voltage	5V
Current Rating	2.5A
Maximum Power Load	12.5W*
USB-C with PD	2 ports
Max Radiated Power	2W / 33dBm
External/Auxiliary device	Maximum 0.9A
Weight	223g





* Total of external devices including RFID reader.

Ordering Information

Reference Number	Description
1930001	MIRI® Evidence PoleReader 8
1930002	MIRI® Evidence PoleReader 9
1930003	MIRI® Evidence TubeReader 8
1930004	MIRI® Evidence TubeReader 9
1930008	MIRI® Evidence ArcReader 8
1930009	MIRI® Evidence ArcReader 9
1910007	MIRI® Evidence RFID Label R3508 (35 x 08 mm)
1910006	MIRI® Evidence RFID Label R4021 (40 x 21 mm)
1910015	MIRI® Evidence RFID Label R5013 (50 x 13 mm)
1910016	MIRI® Evidence CRYO Label BPT3838 (38 x 38 mm)
1910001	MIRI® Evidence CRYO Label BPT2525 (25 x 25 mm)

ESCO LIFESCIENCES GROUP



-  Global Offices
-  Distributors
-  Factories
-  R&D Centers
-  Regional Distribution Centers

Esco Medical Products:

MIRI® Multiroom Incubator
 MIRI® Humidity Multiroom Incubator
 MIRI® II-12 Multiroom Incubator
 Mini MIRI® Dry Multiroom Incubator
 Mini MIRI® Humidity Multiroom Incubator

MIRI® TL6 Time-Lapse Incubator
 MIRI® TL12 Time-Lapse Incubator
 Multi-Zone ART Workstation
 MIRI® Laminar Flow Cabinet
 MIRI® Evidence RFID Witnessing & Traceability System

CelCulture® CO₂ Incubator
 MIRI® GA (Gas and Temperature Validation Unit)
 MIRI® AVT
 CultureCoin®

Infertility is a problem that has a significant social, psychological, and economic impact on afflicted individuals and couples. It is a global concern that knows no race or creed. It has been estimated that 1 in 6 couples struggle with infertility at least once in their lifetime.

Esco Medical is one of the divisions of the Esco Lifesciences Group. We provide innovative technological solutions for fertility clinics and laboratories. We aim to become the leading manufacturer of high-quality equipment such as long-term embryo incubators, ART workstations, anti-vibration tables, and time-lapse incubators.

Our products are designed with the Silent Embryo Hypothesis as a guiding principle. The Silent Embryo Hypothesis states that the less disturbed an embryo can remain, the better its developmental potential will be. Most of our products are designed in Denmark and made in the EU. Our primary focus is to increase pregnancy success rates and patient satisfaction.



Esco Medical, Aps
 Kringelled 10, 8250 Egaa, Denmark
 medical@escolifesciences.com
www.esco-medical.com

Esco Micro, Pte. Ltd. (Headquarters)
 19 Changi South Street 1, Singapore 486 779
 Tel +65 6542 0833

Esco Global Offices: Bangladesh | China | Denmark | Germany | Hong Kong | Indonesia | Lithuania | Malaysia | Myanmar | Philippines | Russia | Singapore | South Africa | South Korea | Taiwan | Thailand | UAE | UK | USA | Vietnam